



BLACK PANTHER
designLAB

PRODUCT CATALOGUE

CONTENTS

ABOUT DESIGN LAB	2
THE CONCEPT HYBRID	4
THE SONICLEAR ATTENUATION SYSTEM	6
THE BLACK PANTHER DESIGN LAB	8
BLACK PANTHER DESIGN LAB SERIES	10
VERSATUS	12
CHERRY BOMB	16
LAB BUILT STANDARDS	18
DRUMMER BUILT OPTIONS	22
BLACK PANTHER DESIGN LAB ARTISTS	42

ABOUT DESIGN LAB

The Design Lab is a group of Artists, Engineers and Designers which form the incubator for unique professional instruments exclusively for Mapex Drums. Using one of a kind sound inspirations and conceived by a revolutionary "Concept Hybrid Formula", the Design Lab creates unique voices, each a combination of the artistry of instrument making and the modern science of drum design.



THE CONCEPT HYBRID

Definition: The process by which multiple sound concepts are combined into a single instrument, resulting in the creation of a new, unique voice.

The Concept Hybrid approach uses the specific blending of different woods, bearing edge profiles, hoop styles, reinforcement rings, lug casings, snare wires, drumheads and even shell finishes to affect the performance and character of a drum. Using this “Sound First” approach, a multiple-tone, sonic concept is chosen and then brought to life by the Mapex Design Lab of Artists, Engineers and Designers.

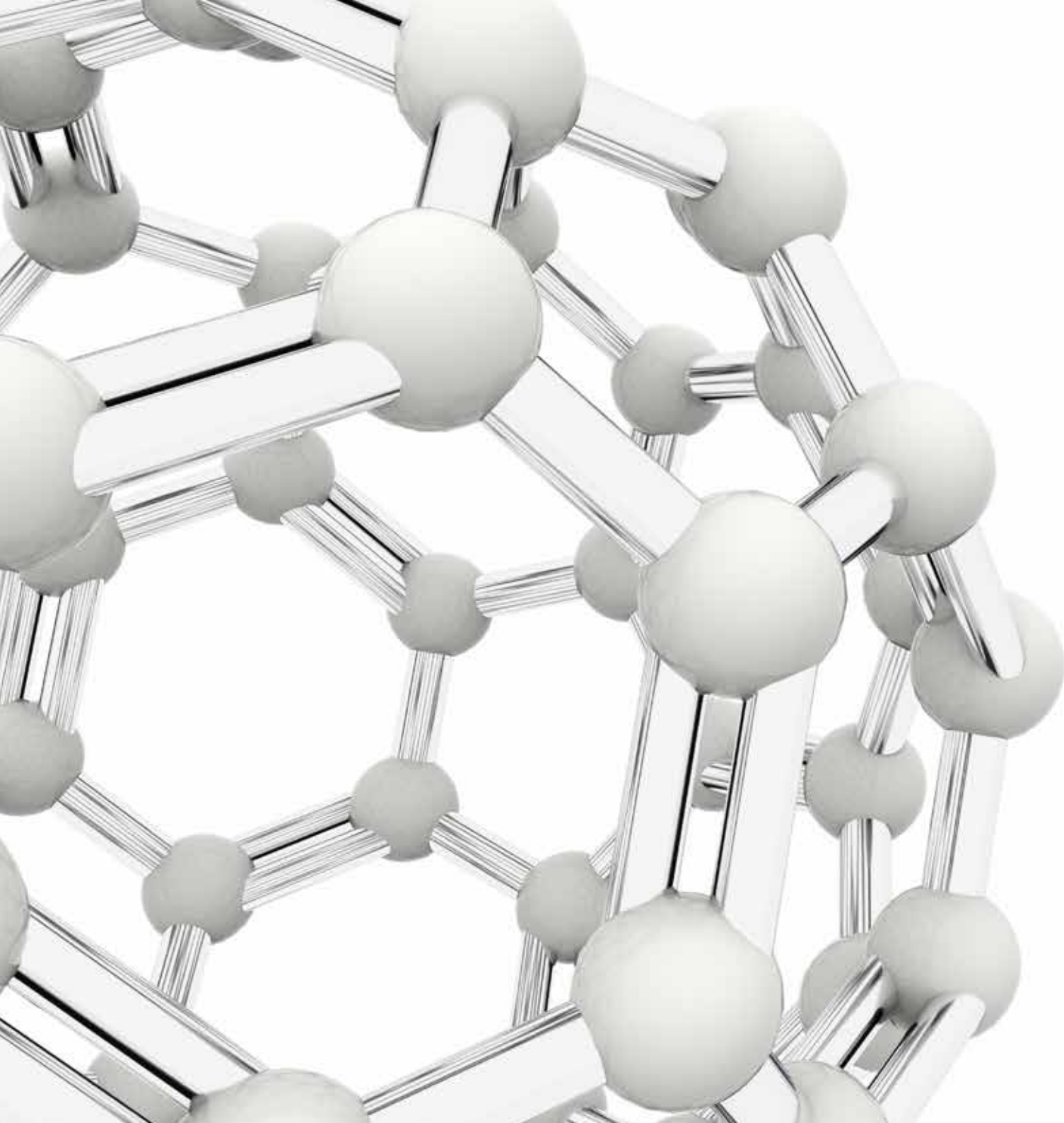



THE SONICLEAR™ ATTENUATION SYSTEM **EXPERIENCE A NEW LEVEL OF CONTROL**

SONIClear™ Attenuation System. Design concepts are based on scientific principles of acoustic properties. This empowers musicians with knowledge, choices, and personal adjustments to achieve the sound that best suits their environment or personal style.



BLACK PANTHER designLAB

The popular Black Panther series has stood as the flagship offering for Mapex drums since its launch in 2010. Now, with a revolutionary approach to instrument design, the NEW Black Panther Design Lab system of drums brings a no holds barred approach to take the Mapex legacy to the next level. Drawing upon the culmination of 30 years of engineering, innovation, artistry and drum craftsmanship, these new drums represent a BREAKTHROUGH in the evolution of acoustic drum science. Relying upon the expertise and experience of renowned artists, each new instrument utilizes the Concept Hybrid approach to begin with a specific sound clearly in mind. Rather than allowing readily available materials and processes to dictate the sonic properties of the instrument, the Design Lab team uses their extensive knowledge of drum-building to make the desired sound a reality, doing whatever it takes to bring that concept to life. This is the foundation of the Black Panther Design Lab approach.





THE DRUM KITS

VERSATUS SYSTEM
CHERRY BOMB SYSTEM





VERSATUS SYSTEM

BPDLV728X

CLASSIC TONE, VERSATILE USABILITY AND ADVANCED DESIGN

JANKA SCALE HARDNESS FOR HARD MAPLE = 1450 / MAHOGANY = 1100

The Black Panther Design Lab Versatus System represents the pinnacle of instrument design. Groundbreaking innovations combine with drum-building mastery to form a unique and extremely versatile instrument. The hybrid Maple and Mahogany shells use the chamber-specific designs of the Black Panther Design Lab. Plies get progressively thicker, depths graduate by 1/2", bearing edges change and the SAS ring system modulates as the drums get larger in diameter. The combination of these details creates an amazing symphony of instruments in one kit, where each and every drum sounds perfect!

FINISHES



NW - SAS 0
Natural Satin

BFB - SAS 0
Satin Black

EW - SAS 1
Transparent Copper

BHW - SAS 1
Rose Burst

BPW - SAS 2
Peach Burl Burst

LW - SAS 2
Gold Sparkle Burst

PB - SAS 1
Piano Black

FEATURES

System Configuration	BPDLV728X
Tom	10" X 7", 12" X 7.5"
Floor Tom	14" X 13", 16" X 15"
Bass Drum	22" X 16"
Aux Drum	18" X 12"
SAS scale	SAS 2 Peach Burl Burst
Bass Drum Hoops	Matching Bass Drum Hoops
Hardware	Black Brushed
Floor Tom, Tom Tom Hoops	Triple Flanged

Versatus Kits (SAS 0, SAS 1, SAS 2- LW)

Sizes	Total (mm)	Ply	Bearing Edges			SAS Ring		
			Batter	Resonant		Batter	Middle	Resonant
TT1007	7.2	6	45°	45°	-	-	-	
TT1275	7.2	6	45°	45°	✓	-	-	
TT1308	7.2	6	45°	45°	-	-	✓	
FT1413	7.2	6	60°	60°	✓	-	✓	
FT1615	9.6	8	60°	60°	✓	-	✓	
BF1812	10.6	10	60°	60°	-	-	-	
BD2216	10.6	10	60°	60°	✓	✓	✓	

Versatus Kits (SAS 2- PW)

Sizes	Total (mm)	Ply	Bearing Edges			SAS Ring		
			Batter	Resonant		Batter	Middle	Resonant
TT1007	7.55	7	45°	45°	-	-	-	
TT1275	7.55	7	45°	45°	✓	-	-	
TT1308	7.55	7	45°	45°	-	-	✓	
FT1413	7.55	7	60°	60°	✓	-	✓	
FT1615	9.95	9	60°	60°	✓	-	✓	
BF1812	10.95	11	60°	60°	-	-	-	
BD2216	10.95	11	60°	60°	✓	✓	✓	

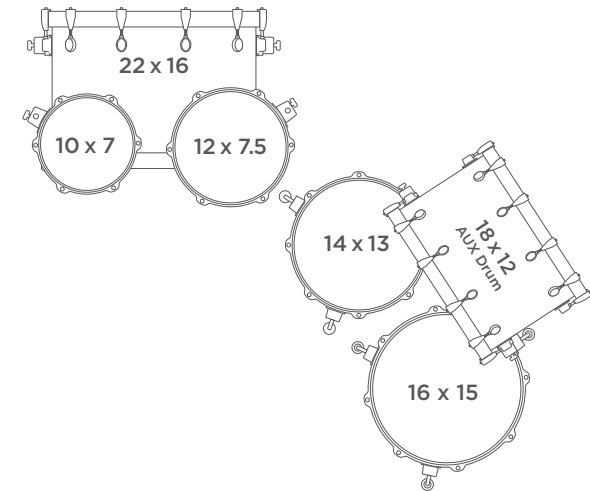

COMPONENTS

Tom	8" x 6.5"	BPDLVT865PK
	10" x 7"	BPDLVT1007PK
	12" x 7.5"	BPDLVT1275PK
	13" x 8"	BPDLVT1308PK
Floor Tom	14" x 13"	BPDLVF1413
	16" x 15"	BPDLVF1615
	18" x 16"	BPDLVF1816
Bass Drum	18" x 15"	BPDLVB1815A
	20" x 15"	BPDLVB2015A
	22" x 16"	BPDLVB2216A
	24" x 15"	BPDLVB2415A



Standard Configuration 1

14

VERSATUS SYSTEM

STANDARD CONFIGURATION



Standard Configuration 3



Standard Configuration 2

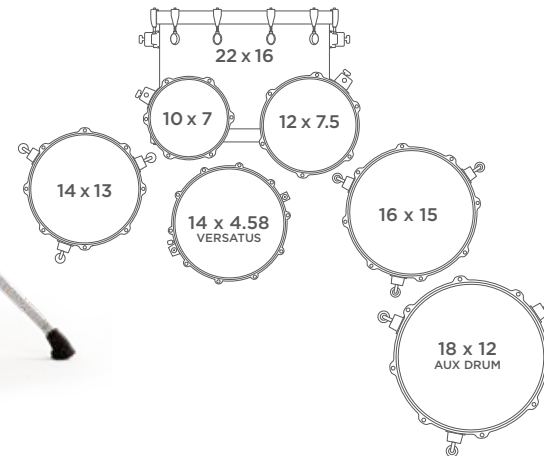

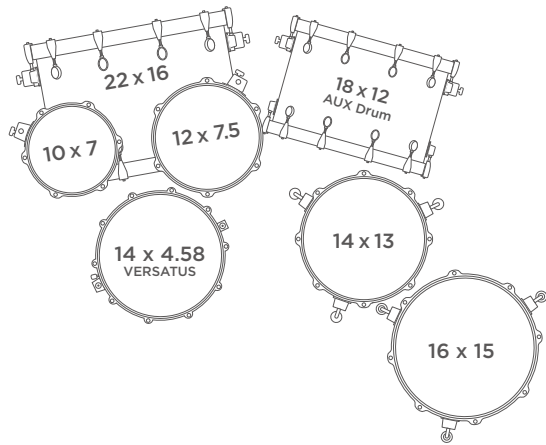

Split Kit 2



Split Kit 1

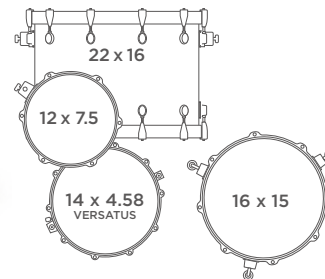
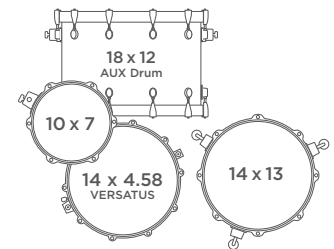

CHERRY BOMB SYSTEM

BPDL528X

VINTAGE, CONTROLLED, PRECISE

JANKA SCALE HARDNESS FOR CHERRY = 950, SCALE: 380 - 4380

The Black Panther Design Lab Cherry Bomb system is a very unique sound for modern drums. Using all-cherrywood 1mm plies, the Cherry Bomb's focus is unmatched. High toms descend in 1/2" depths to retain their drive and punch, producing an incredible Vintage tone with the body of modern drums. The Cherry Bomb system is a hybrid of the classic sounds of beloved vintage drums, with modern hardware and cutting edge technology.

FINISHES



NW - SAS 0
Natural Satin

BFB - SAS 0
Satin Black

EW - SAS 1
Transparent Copper

BHW - SAS 1
Rose Burst

BPW - SAS 2
Peach Burl Burst

LW - SAS 2
Gold Sparkle Burst

PB - SAS 1
Piano Black

FEATURES

System Configuration	BPDL528X
Tom	12" x 8"
Floor Tom	14" x 14", 16" x 16"
Bass Drum	22" x 16"
SAS scale	SAS 0 Natural Satin
Bass Drum Hoops	Natural Satin Maple Bass Drum Hoops
Hardware	Chrome
FLOOR TOM, TOM TOM HOOPS	SONIC SAVER

Cherry Bomb Kits (SAS 0, SAS 1, SAS 2- LW)

Sizes	Toatl (mm)	Ply	Bearing Edges	
			Batter	Resonant
TT1208	5.8	6	45°	45°
FT1414	5.8	6	45°	45°
FT1616	8.2	8	60°	60°
BD2216	8.2	8	60°	60°

Cherry Bomb Kits (SAS 2- PW)

Sizes	Toatl (mm)	Ply	Bearing Edges	
			Batter	Resonant
TT1208	6.15	7	45°	45°
FT1414	6.15	7	45°	45°
FT1616	8.55	9	60°	60°
BD2216	8.55	9	60°	60°

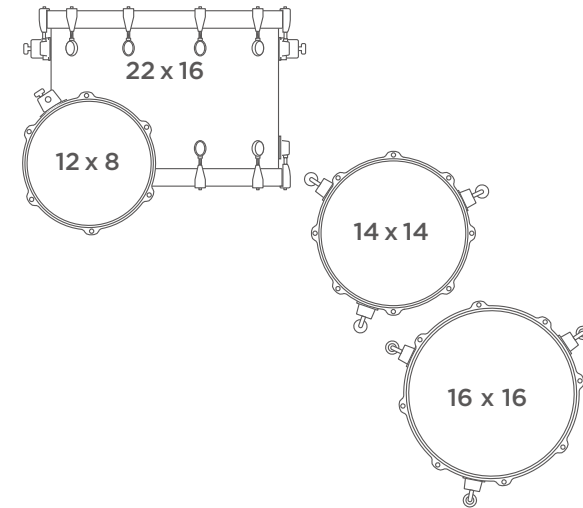

COMPONENTS

Tom	8" x 7"	BPDLCT807PK
	10" x 7.5"	BPDLCT1075PK
	12" x 8"	BPDLCT1208PK
	13" x 8.5"	BPDLCT1385PK
Floor Tom	14" x 14"	BPDLCF1414
	16" x 16"	BPDLCF1616
	18" x 16"	BPDLCF1816
Bass Drum	18" x 14"	BPDLCB1814A
	20" x 14"	BPDLCB2014A
	22" x 16"	BPDLCB2216A
	24" x 14"	BPDLCB2414A





Standard Configuration

LAB BUILT STANDARDS

Soniclear Features

Mapex-specific designs that lead to better sound and operation

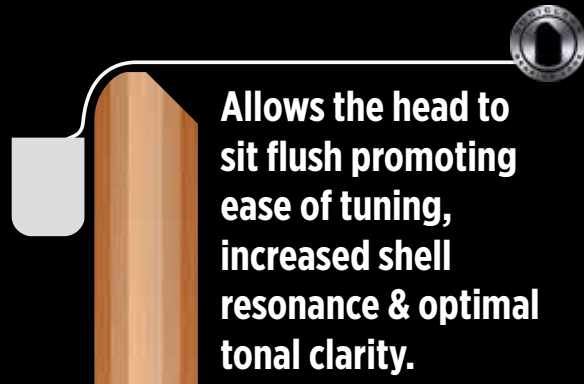

Soniclear™ Bearing Edge



Master Tune Lug™



Sonic Pedestal Foot

System features

Lead to better sound and operation



Chamber Specific Designs



Air Flow Venting



Isolation Gasket (Floor Tom)



Static 90° Floor Tom Legs

SONICLEAR™ BEARING EDGE MASTER TUNE LUG™

Is standard on all BPDF shells, allowing the drumhead to sit flatter on the shell, making better contact. The result is a stronger and deeper fundamental pitch, effortless and consistent tuning, and a significantly expanded tuning range. For the serious player, the increased head-to-edge contact increases shell vibration, allowing the sonic nuances of the hybrid shell to stand out.

The elegant design of this distinctive Black Panther lug has been revised by the Design Lab to form the new Master Tune Lug. The first truly "Locking Tube Lug", the Master Tune Lug utilizes a small body for the least amount of metal-to-wood contact. A Design Lab-exclusive pressured locking mechanism is outfitted on every lug to keep the drum in tune, show after show.

SONIC PEDESTAL FOOT

The steel leg is prevented from contacting the ground by an internal cotter pin, allowing the floor tom to "float" on the elevated "spring" of the rubber foot, eliminating vibration transfer and maximizing resonance.

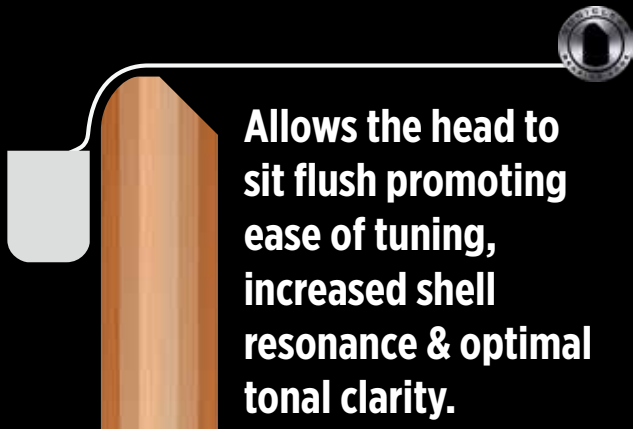

Allows the head to sit flush promoting ease of tuning, increased shell resonance & optimal tonal clarity.



CHAMBER SPECIFIC DESIGN

Plies get progressively thicker, depths graduate by 1/2", bearing edges change and the SAS ring system changes as the drums get larger in diameter. The combination of these details creates an amazing symphony in one kit, where each and every drum sounds perfect!

AIR FLOW VENTING

One of the amazing elements to playing the Black Panther Design Lab drums is the "feel" of the instrument. The venting is key to the feel and the overall resonance of the shells. Through painstaking testing, each Chamber Specific approach has led to a formula of multiple vent holes in both Design Lab systems. Toms and bass drums have different combinations of vent holes. These air flow vents are strategically positioned in alignment with the lugs, so as to not affect the resonance of the shells.

ISOLATION GASKET (FLOOR TOM)

All Design Lab floor toms have the new "lift" bracket design. The metal components of the floor tom brackets are now entirely on the outside of the shell, isolated by the special rubber lift gasket. This releases all pressure from the shell, alleviating vibration loss. The 90° Leg design was also given strong consideration in regard to its sonic implications. The straighter the path to the floor, the more sound is lost. Hence, the 90° "static" Design Lab legs allow the most possible resonance from the floor toms and Aux Drum™. This can then be attenuated in real-time with the SAS version of this leg.



SAS STATIC 90° FLOOR TOM LEG

The straighter the path to the floor, the more sound loss: the static 90° Design Lab leg resolves this issue, allowing the most possible resonance from the floor toms.



DRUMMER BUILT OPTIONS

SAS Features

Real Time Adjustable ●, User Selectable ○



SAS Attenuating Floor Tom Leg™

●



Magnetic Force Adjustment and Acoustic Resonate Gate on MAATS

●



SAS Ring System

○



Auxiliary (Aux) Drum™

●○

Build Your Sound

Selectable Hoops, Finishes, Hardware Fittings



Bass Drum, Tom Tom, Floor Tom Hoops



SAS Finishes

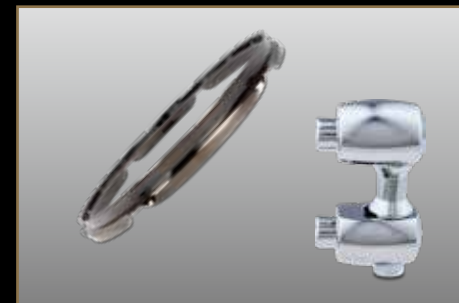

Hardware Fittings

SAS ATTENUATING FLOOR TOM LEG™

This BREAKTHROUGH eliminates the need for external muffling of your floor toms. Given that a straighter path to the ground through the floor tom legs results in greater loss of sound, the ability to alter their shape allows you to control the resonance. With options for every angle, even beyond 90° to a radical inverted position, the SAS floor tom leg makes unlimited real-time attenuation of your drums possible.

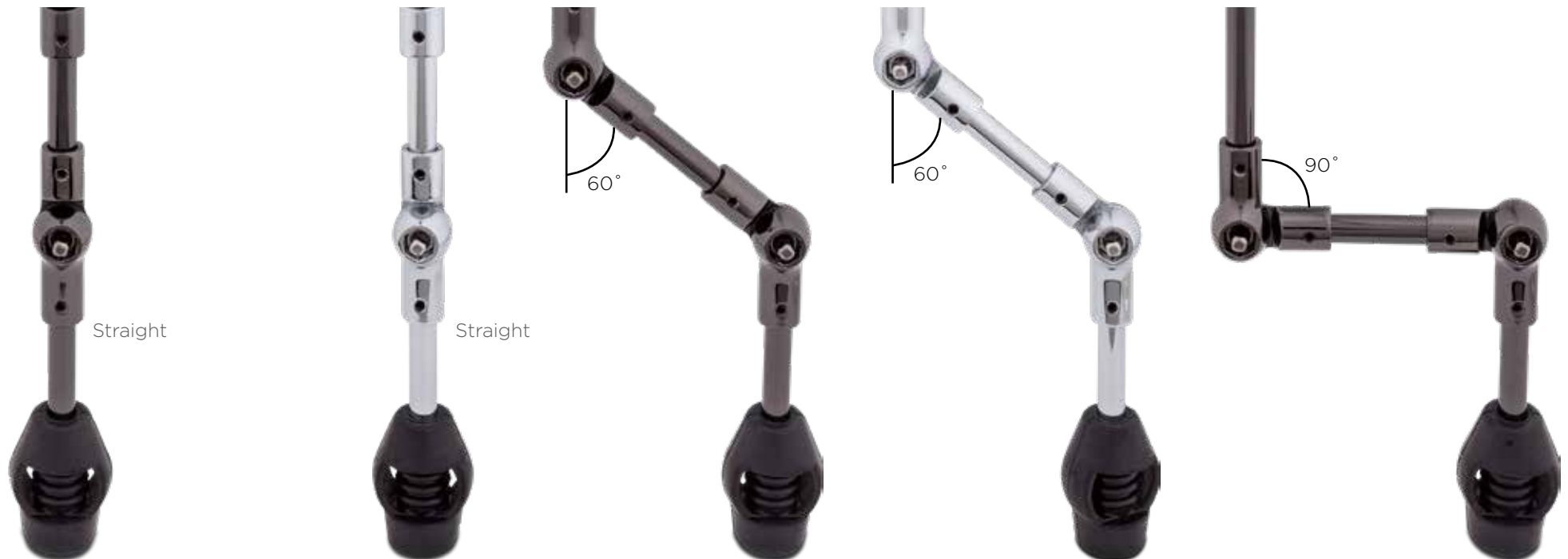

MAGNETIC AIR ADJUSTMENT TOM SUSPENSION

Revolutionary..... It's the only word to describe the Magnetic Air Adjustment Tom Suspension (MAATS-A) System for acoustic drums. This is a brand new approach to mounting and sonically suspending the toms on your drum kit. Invented by Randall May International Inc., and tailored for Mapex Black Panther Design Lab, MAATS-A was developed to accentuate and attenuate the purity of the instrument's sonic properties. It also gives the opportunity to personalize the response of the drum to each player's personal preference. The result is an unprecedented sound and feel, alleviating vibration transfer loss. The multiple US & International Patent Pending MAATS system mitigates the weight of the drum into a dynamically/floating magnetic space field. Thus, allowing for the for magnetic adjustment to custom define the sustain and note size individually for each drum.

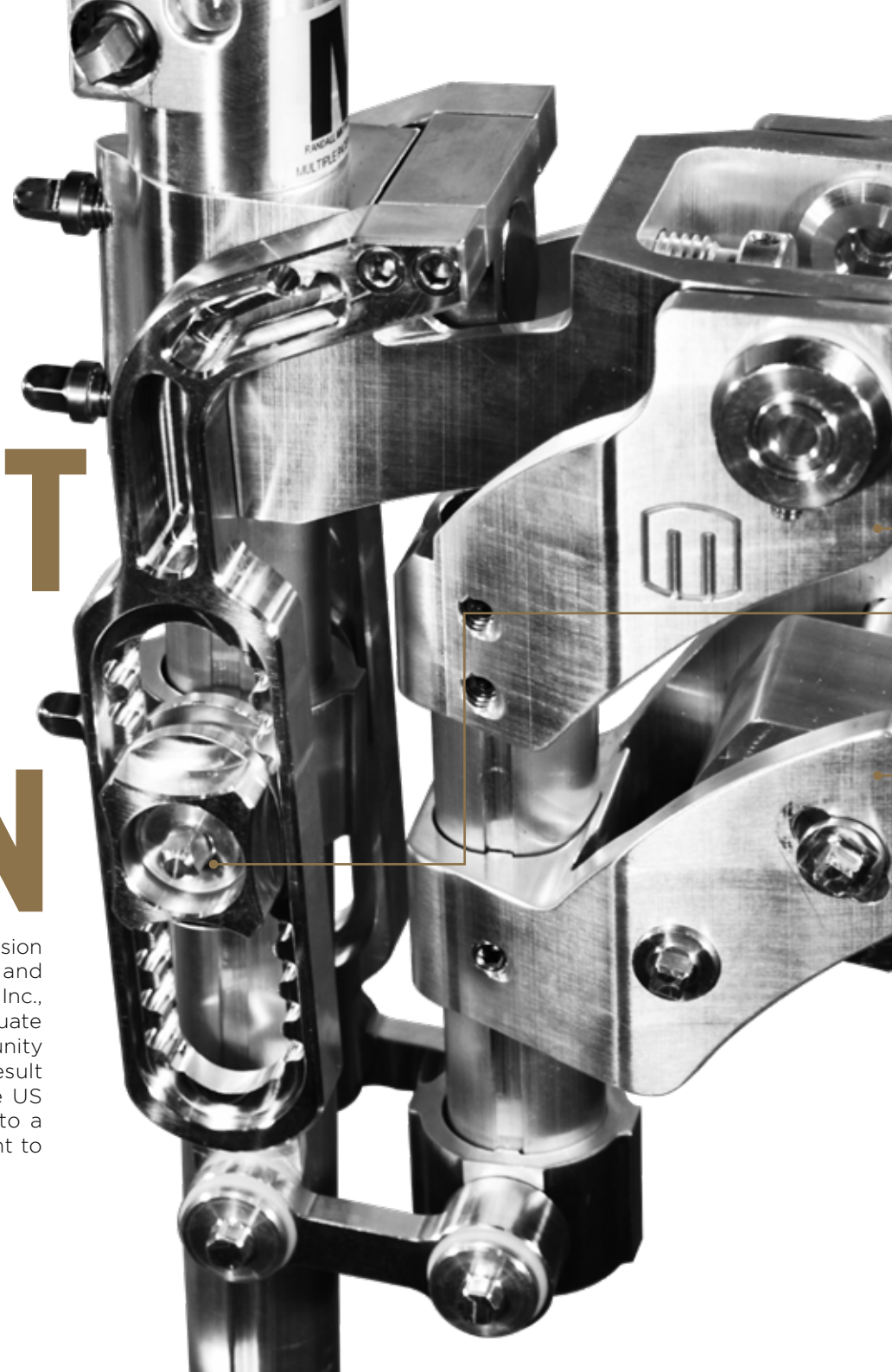

“MFA” - Magnetic Force Adjustment™

The “MFA” or Magnetic Force Adjustment controls how much of the weight of the drum you are allowing the magnets to pick up. As you apply magnetic force, the sound opens because the weight is being distributed to the opposing magnets.



“ARG” - Acoustic Resonance Gate™

As the positioning of the ARG moves up and down, the sustain length of the drum lengthens or shortens. This is an incredible way to dial in your perfect drum sound in real time!

Drum Leverage (Drum Size) Adjustment

The Drum Leverage position adjusts to any mounted tom size.



Ergonomic Positioning for Tuning or Performance

1. A 360° spin while still secured on the mount, allows for tuning of the resonant head while holding the drum in position.
2. A 20° angle adjustment feature in the bridge receptor, allows for adjustment to the perfect playing position.



MAATS™ A

RANDALL MAY INTERNATIONAL MAGNETIC AIR ADJUSTMENT TOM SUSPENSION FOR ACOUSTIC DRUMS

SAS RING SYSTEM

The Mapex Black Panther Design Lab uses a revolutionary process involving reinforcement rings. Rather than using rings solely for the purpose of keeping thin-shelled drums round, Mapex focuses on how the use of rings and their unique placement can affect the sonic character of the instrument. The first example of this approach by Mapex came with the design of the Black Panther artist inspired "Versatus" snare drum. A batter-side-only ring was used to create a "vintage" style tone: applying more wood at the top edge gave the drum a thicker - or "fatter" - sounding rimshot and backbeat compared to most shallow-depth snares. The absence of a ring on the bottom edge maintained the articulation and sensitivity necessary for lower-volume playing, whether that be ghost-notes or playing with brushes. This breakthrough concept was then applied to the entire Versatus system kit with amazing results. These "Sonic" rings are distributed in varying degrees throughout the system. The table below shows the layout of the Versatus SAS Rings.

Size	Type	SAS Rings	Position		
			Batter Side	Center	Resonant Side
8"	Tom	No Rings			
10"	Tom	No Rings			
12"	Tom	(1) 4-Ply/1" Maple Rings	v		
13"	Tom	(1) 4-Ply/1" Maple Rings			v
14"	Floor Tom	(2) 4-Ply/1" Maple Rings	v		v
16"	Floor Tom	(2) 4-Ply/2" Maple Rings	v		v
18"	Aux Drum	No Rings			
18"	Bass Drum	No Rings			
20"	Bass Drum	(2) 4-Ply/1" Maple Rings	v		v
22"	Bass Drum	(3) 4-Ply/2" Maple Rings	v	v	v
24"	Bass Drum	(3) 4-Ply/2" Maple Rings	v	v	v





AUXILIARY DRUM (AUX DRUM™)

Another unique concept from the Design Lab is the new Aux Drum™. This “3-in-1” instrument concept opens a whole new world of versatility within a single drum. The Aux Drum™ has been designed to be a small diameter bass drum, a “gong” bass drum and also a “gong” floor tom all in one convenient and great-sounding instrument.

Aux Drum™ Specifications:

- 18” Diameter X 12” Deep 9-Ply (10.8 mm) Maple / Mahogany Shell
- Features the “Versatus” system Shell formula
- Batter side bass drum head and hoop
- Resonant side tom head and hoop
- A new 3-Point bracket positioning that allows for complete flexibility of set-up
- Includes removable spurs for bass drum set-up
- Includes 3, Design Lab 90° “Static” floor tom legs for the “gong” floor tom
- “3-Point” bracket positioning allows for the Aux Drum™ to be mounted via two TH800 Soniclear tom arms on cymbal stands
- Special “slotted” batter side bass drum hoop, allows for proper pedal positioning on the AC909 bass drum “lift” (Included)
- Available in all colors of Black Panther Design Lab and with hoop selection options





Small Diameter Bass Drum



“Gong” Floor Tom



“Gong” Bass Drum

**“3-IN-1”
INSTRUMENT CONCEPT**

BUILD YOUR SOUND

**SONIC EFFECT SCALE
HOOP & HARDWARE OPTIONS
SAS FINISH VALUES
CROSS OVER FINISHES
CUSTOMIZED KITS**



BUILD YOUR SOUND WITH SAS SONIC EFFECT SCALE

Black Panther Design Lab drum kits allow drummers to customize based on the proprietary "SAS Sonic Effect Scale" developed by Mapex Drums. By selecting finishes, hoops, and hardware fittings to suit your style and taste, you can also create sound that is all your own. You can further utilize a combination of both Versatus and Cherry Bomb shells to create a unique set-up with the resonance and control that best suits you and your musical needs.

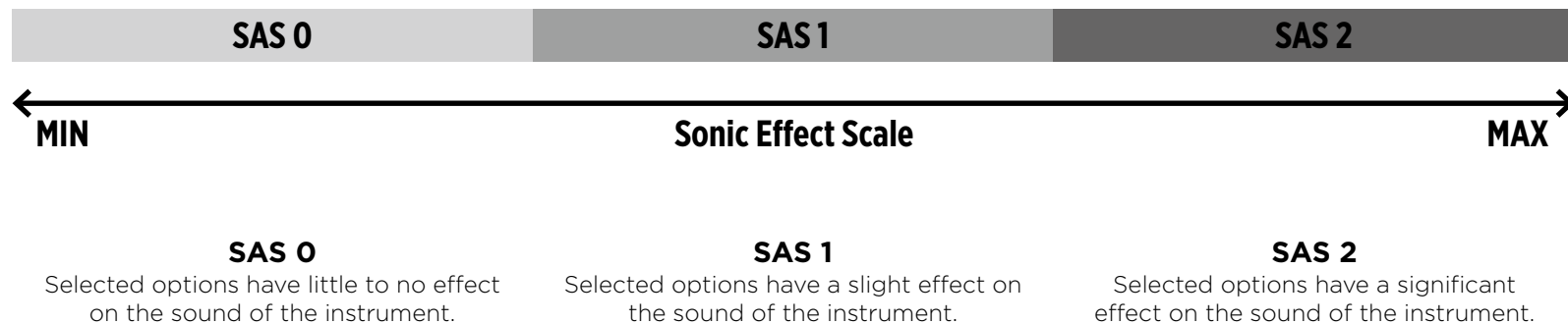

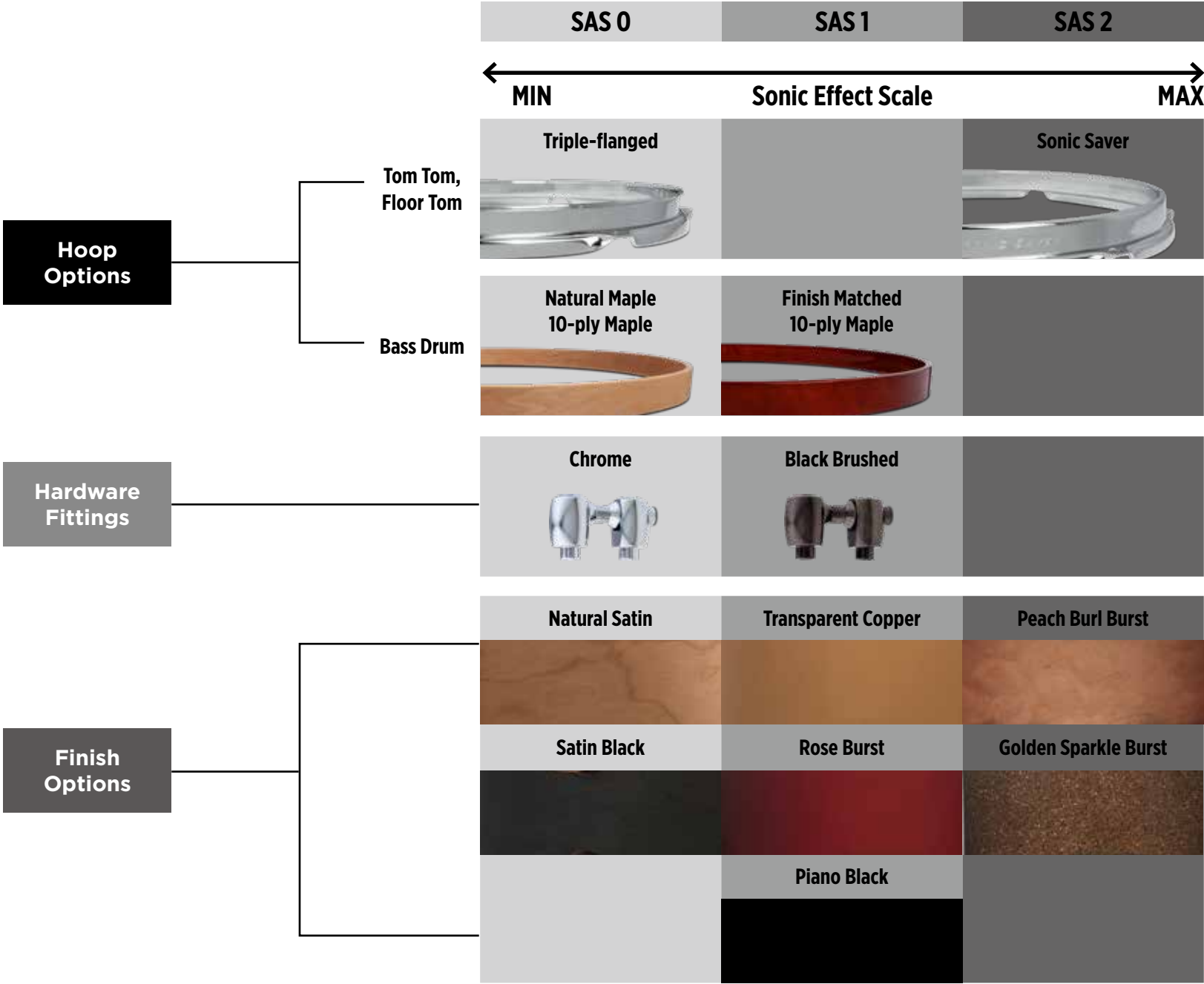

HOOP & HARDWARE OPTIONS



Triple-flanged (SAS 0)

Their lighter weight facilitates the most ambience from the drums. They also have more stick attack and a metallic voice for rimshots.



Sonic Saver (SAS 2)

The inward flange and extra weight of the Sonic Saver hoops help to focus and control the sound of the drums. The projection is more "down" than "out" and will provide more of a "vintage" or closed tone.



Natural Maple 10-Ply Maple (SAS 0)

The new "Soniclear Bass Drum Hoops" have a smaller diameter, a beveled internal edge and rounded external edges, help the bass drum heads seat better and tune more easily. Available in this "Vintage" satin natural maple finish as an SAS 0.



Finished Matched 10-ply Maple (SAS 1)

The new "Soniclear Bass Drum Hoops" are also available in the finish matching your kit. These are high-gloss lacquered, stained 10-ply Maple hoops, in an SAS 1 finish level.



Chrome Plated (SAS 0)

The timeless look of chrome plated hardware.



Brushed Black Nickel Plated (SAS 1)

Adds a special modern visual touch to finish combinations.

SAS FINISH VALUES

An SAS 0 Finish brings out the beautiful grain and color character of the woods used in the drums, but also allows the shell to vibrate fully due its extremely low-mass application. Thicker finishes like high-gloss veneers and wraps add mass to the shell and shorten sustain, as well as raising the pitch. A frequently neglected facet of drum design is taking into consideration what finish you are choosing for the sonic properties of the instrument. Of course, players always want their instrument to look great, so there is a balance between what look and presentation is desired for the drums and what effect that finish will have on the actual sound. Here are the different SAS finishes available on the Black Panther Design Lab Systems:

SAS (SONIClear Attenuation System) Finish Values

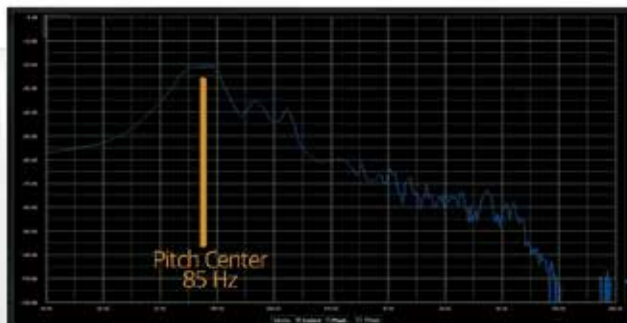
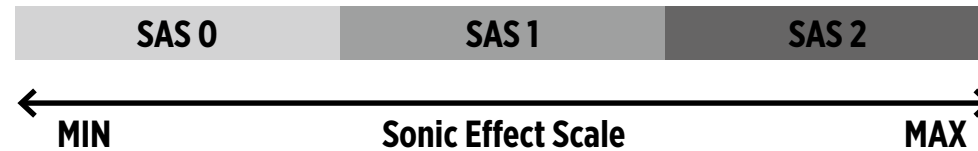

SAS 0 - Stained or Natural Satin Finish

A stained or natural satin lacquer finish gives you the option of applying wood stains to the outside of the drum's shell. This gives many more color options, relative to the natural color of the wood. A rubbed satin finish adds light lacquer and sealant, which creates some protection for the shell. The Satin finish on Design Lab is an SAS 0 and has little to no effect on the sound of the instrument.

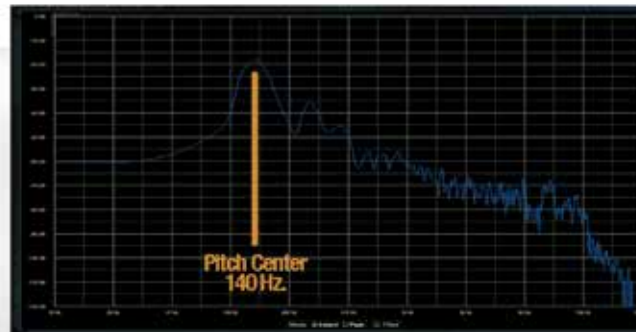

SAS 1 - Stained or Natural Gloss Lacquer Finish

Stained, solid or natural gloss lacquer finishes offer the beautiful, classic look known for high-end instruments such as pianos, drums and guitars. The high-gloss lacquer is done by coating, buffing and re-coating gloss lacquer many times on the natural shell. While this makes a deep, attractive finish, it does however inhibit the movement of the drum shell because of the thickness of the lacquer coating. Design Lab Gloss lacquers are SAS 1 because of the slight dampening of the drum's overall resonance and raising of the pitch.

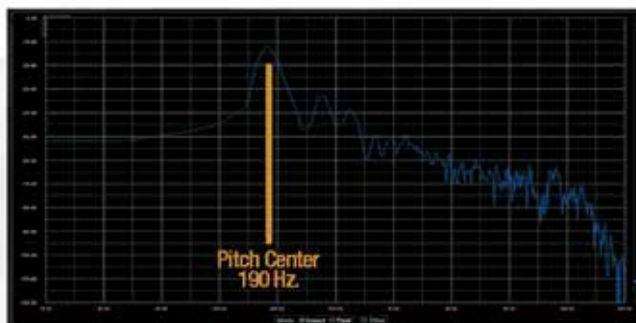
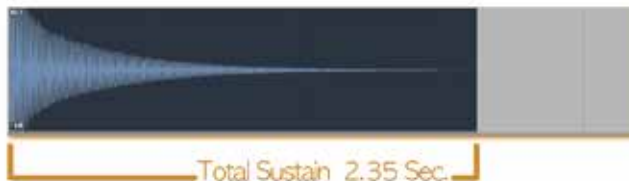

SAS 2 - Exotic Wood Veneers and Deep Sparkles with Gloss Lacquer Finish

A veneered lacquer finish is the most expensive looking of all of the instrument finishes. A stunning, exotic presentation, these beautiful Maple Burl Veneers have the addition of a high-gloss lacquer. Deep Sparkles are also included in the SAS 2 level finishes due to the additional layers of sparkle and lacquers. Though the most attractive of all the finishes, the extra layers of glued wood, sparkles and many coats of high-gloss lacquer considerably inhibits the shell's resonance. Design Lab's Veneered and Deep Sparkle finishes are SAS 2 because of the short sustain and the additional raising of the shell's fundamental pitch.

CROSS OVER FINISHES

The SAS finish system is designed with “crossover” finishes. This means that you can now configure the Design Lab kit that best suits your sonic tastes and musical style! For instance, you could combine the amazing dynamic range and low fundamentals of the Versatus bass drums with the punch, drive and precision of the Cherry Bomb toms to create a unique and personal sound. With a complete offering of crossover finish options (**except Natural Satin), you can select the perfect instruments to build your personal inventory of Black Panther Design Lab drums.



CUSTOMIZED KITS

CHERRY BOMB

Snare	BP Warbird (not included in the drum kit)
Tom	12" x 8"
Floor Tom	14" x 14"
Bass Drum	18" x 16"
SAS Scale	SAS 1 Rose Burst
Bass Drum Hoops	Natural Satin Maple Bass Drum Hoops
Hardware	Black Brushed
Floor Tom, Tom Tom Hoops	Triple Flanged





CHERRY BOMB

Snare	Design Lab Heartbreaker (not included in the drum kit)
Tom	12" x 8", 13" x 9"
Floor Tom	16" x 16", 18" x 16"
Bass Drum	24" x 14"
SAS Scale	SAS 1 Transparent Copper
Bass Drum Hoops	Matching Bass Drum Hoops
Hardware	Chrome
Floor Tom, Tom Tom Hoops	Sonic Saver

CHERRY BOMB

Snare	Black Panther Design Lab Cherry Bomb & BP Versatus (not included in the drum kit)
Tom	8"x7", 10"x7.5", 12"x8"
Floor Tom	14"x14", 16"x16", 18"x16"
Bass Drum	(2)"22"x16"
SAS Scale	SAS 2 Peach Burl Burst
Bass Drum Hoops	Matching Bass Drum Hoops
Hardware	Black Brushed
Floor Tom, Tom Tom Hoops	Triple Flanged



VERSATUS

Snare	BP Versatus
Tom	10" x 7", 12" x 7.5"
Floor Tom	14" x 13", 16" x 15"
Bass Drum	22" X 16", 18"x12" (Aux Drum)
SAS Scale	SAS 1 Rose Burst
Bass Drum Hoops	Matching Bass Drum Hoops
Hardware	Black Brushed
Floor Tom, Tom Tom Hoops	Triple Flanged



VERSATUS

Snare	Black Panther Design Lab Equinox
Tom	12"x7.5"
Floor Tom	14"x13", 16"x15"
Bass Drum	18"x15"
SAS Scale	SAS 0 Satin Black
Bass Drum Hoops	Natural Satin Maple Bass Drum Hoops
Hardware	Chrome
Floor Tom, Tom Tom Hoops	Triple Flanged



VERSATUS

Snare	BP Warbird
Tom	10"x7", 12"x7.5"
Floor Tom	14"x13", 16"x15"
Bass Drum	22"x16", 22"x16", 18"x12"
SAS Scale	SAS 1 Rose Burst
Bass Drum Hoops	Matching Bass Drum Hoops
Hardware	Black Brushed
Floor Tom, Tom Tom Hoops	Triple Flanged





VERSATUS

Snare	Black Panther Design Lab Heartbreaker
Tom	13"x 8"
Floor Tom	16" x 15", 18"x16"
Bass Drum	24"x15"
SAS Scale	SAS 1 Transparent Copper
Bass Drum Hoops	Matching Bass Drum Hoops
Hardware	Chrome
Floor Tom, Tom Tom Hoops	Sonic Saver



VERSATUS

Snare	Black Panther Design Lab Cherry Bomb
Tom	8"x6.5", 10"x7", 12"x7.5"
Floor Tom	14"x13", 16"x15"
Bass Drum	20"x15", 18"x12" Aux. Drum (Gong BD)
SAS Scale	SAS 2 Gold Sparkle Burst
Bass Drum Hoops	Matching Bass Drum Hoops
Hardware	Chrome
Floor Tom, Tom Tom Hoops	Sonic Saver





Alex Landenburg

Kirk Covington

Claus Hessler

Rashid Williams

Chris Adler

BLACK PANTHER DESIGN LAB ARTISTS

**Russ Miller****Jeff Hamilton****Greg Hutchinson****Craig Blundell****Lee Pearson**

The finest drummers are musicians first and foremost: they express a distinct artistic identity through their drums. They place a very high value on excellent design and execution of manufacturing; Sound, playability and appearance are of paramount importance. The Black Panther Design Lab artist roster consists of drumming luminaries and legends, representing a range of genres and styles, each one an undisputed master of their craft. They have one thing in common: they have chosen some of the finest instruments ever made to deliver their unique, individual voices. So what does it take to change the way we all think about drum design? We at MAPEX think it's actually very simple. It takes 10 of the best drummers in world to play the same series of drums.

ARTIST KIT CHOICE

VERSATUS

Finish: Natural Satin (SAS 0) / Matching BD Hoops
Hardware: Black Brushed / Hoops: Triple-flanged

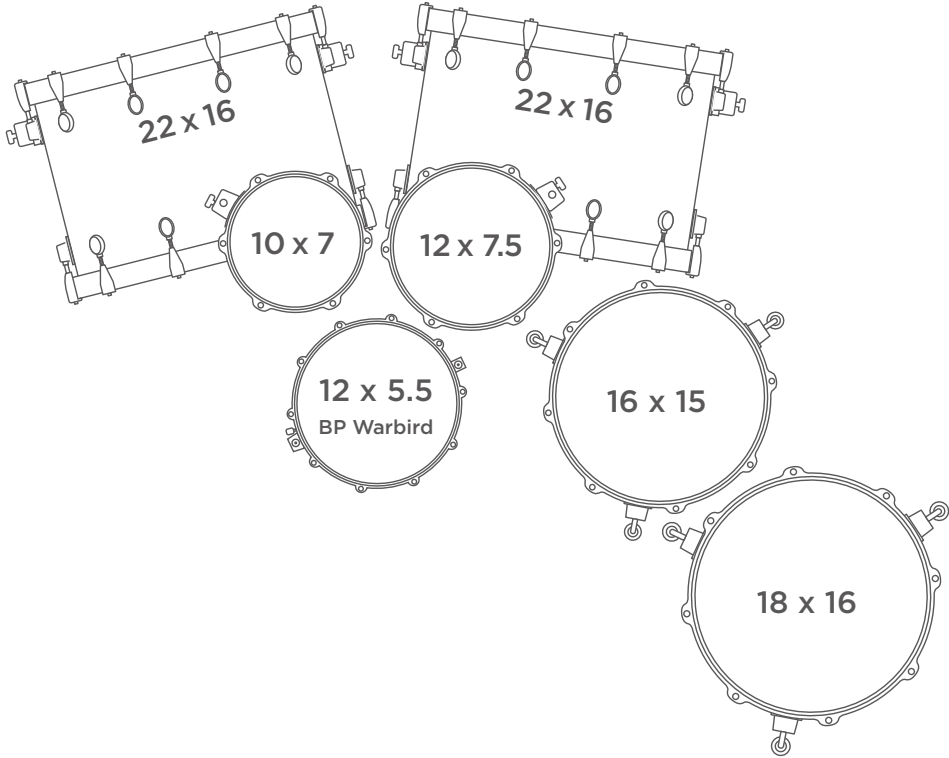

"You don't need to add anything. It's all there and has a lot more of what you want. It's quick, it sings, it's awesome!"

There are few thrones in modern metal as revered as that of Chris Adler, whose double bass Versatus rig is the perfect complement to his trademark drive and aggressive style of playing. The high-definition sonic properties of the Versatus focuses its full resonance into punch and attack without losing body.

CHRIS ADLER

LAMB OF GOD



ARTIST KIT CHOICE

VERSATUS

Finish: Piano Black (SAS 1) / Matching BD Hoops
Hardware: Black Brushed / Hoops: Triple-flanged

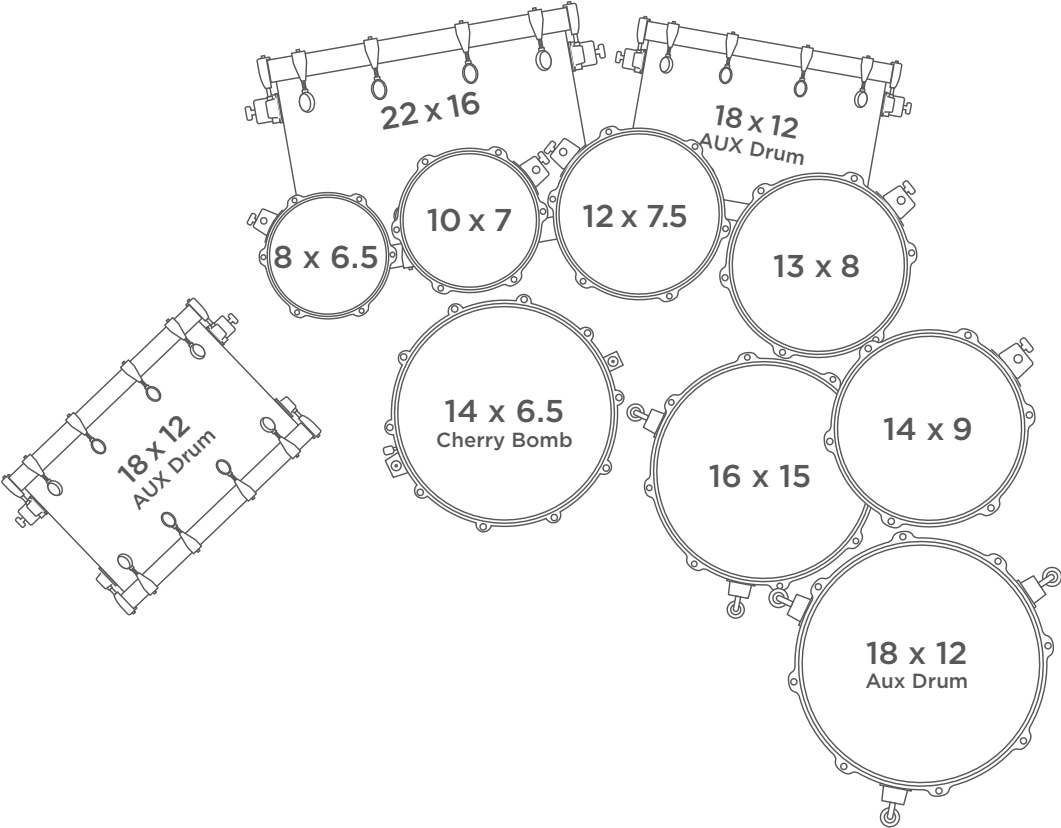

"This new drumset is going to give me all the resonance and control I'll ever need. Regarding my perfect, EQ'd sound: out of the box, it's there."

This imposing rig is the ideal delivery system for Craig Blundell's signature complexity. Rack toms sing with an open, natural resonance with a trace of menace low-end bark. The artist's technical, intricate patterns demand a focused, perfectly EQ'd sound and with an aggressive attack to add pop for live environments.

CRAIG BLUNDELL

STEVE WILSON



ARTIST KIT CHOICE

VERSATUS

Finish: Transparent Copper (SAS 1) / Matching BD Hoops

Hardware: Chrome / Hoops: Triple-flanged

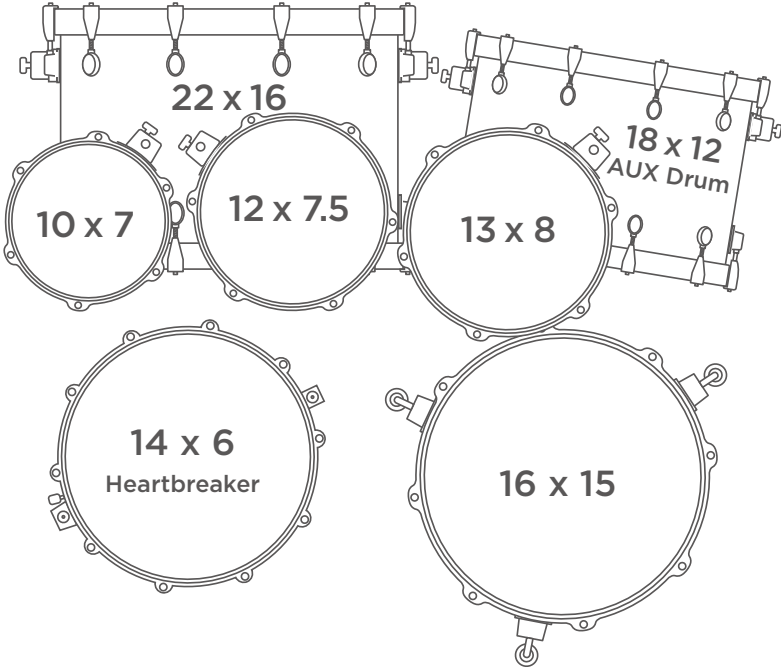

"From a drummer's stand point, nothing has been left out, nothing has been overlooked. So if there is such a thing as perfect; these are it."

The versatile musician merits a versatile instrument, and it's all in the name with Kirk Covington's Versatus drum kit. The complete Versatus system kit allows the artist to pick the right size drums for every format: from the classic club gig setup to a full funk/fusion rig, it's all in the mix.

KIRK COVINGTON

TRIBAL TECH



ARTIST KIT CHOICE

CHERRY BOMB

Finish: Piano Black (SAS 1) / Matching BD Hoops
Hardware: Black Brushed / Hoops: Triple-flanged

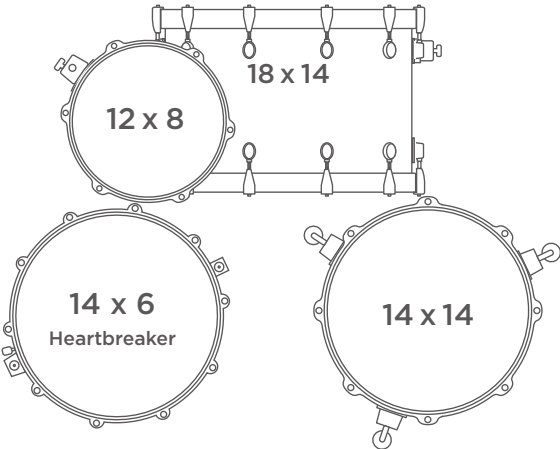

"You just play a drum and it lets you get a big sound. The response is so immediate, and there was that warm sound on each one of the drums."

The Cherry Bomb in the classic 4 piece setup is the choice of eminent jazz maestro Jeff Hamilton. An immediacy of response jumps out from the cherry wood shells, before spreading out with a warmth that organically integrates with the band's sound without cutting through it, embracing rather than confronting the listener.

JEFF HAMILTON

LEGENDARY TOURING &
RECORDING MUSICIAN



ARTIST KIT CHOICE

CHERRY BOMB

Finish: Satin Black (SAS 0) / Natural Maple BD Hoops
Hardware: Chrome / Hoops: Sonic saver

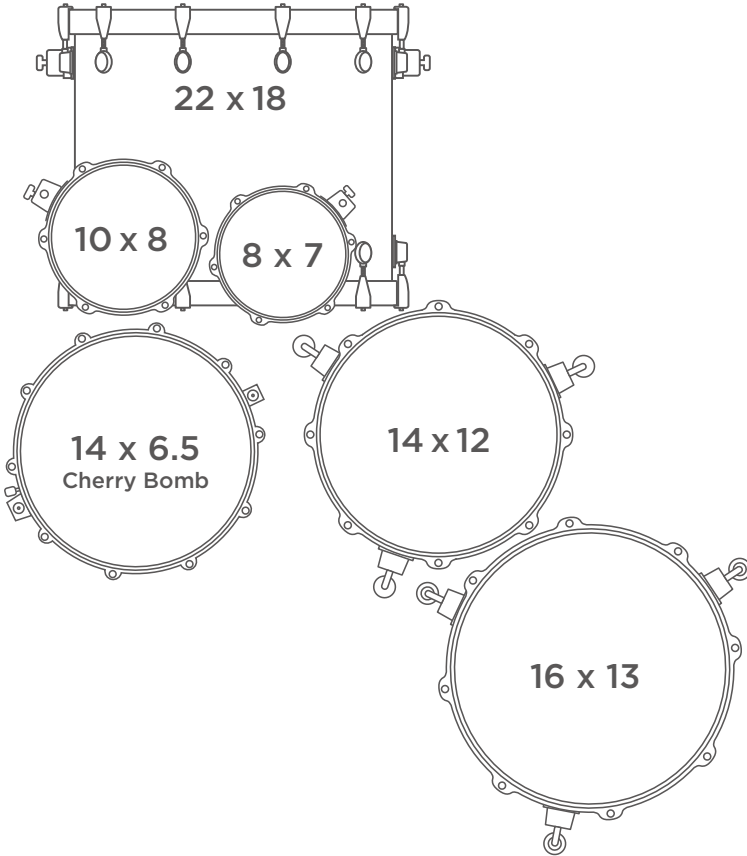

"I don't think I've ever played a set of drums which offered more of what I was looking for."

Claus Hessler's unorthodox Cherry Bomb setup stems from his mastery of open hand playing, giving rise to extremely progressive orchestrations and ostinatos. The cherry wood shell formula sings with warmth, with plenty of teeth and punch from the low end.

CLAUS HESSLER

FLUX



ARTIST KIT CHOICE

VERSATUS BD/ CHERRY BOMB TOMS

Finish: Peach Burl Burst (SAS 2) / Matching BD Hoops

Hardware: Chrome/ Hoops: Sonic Saver

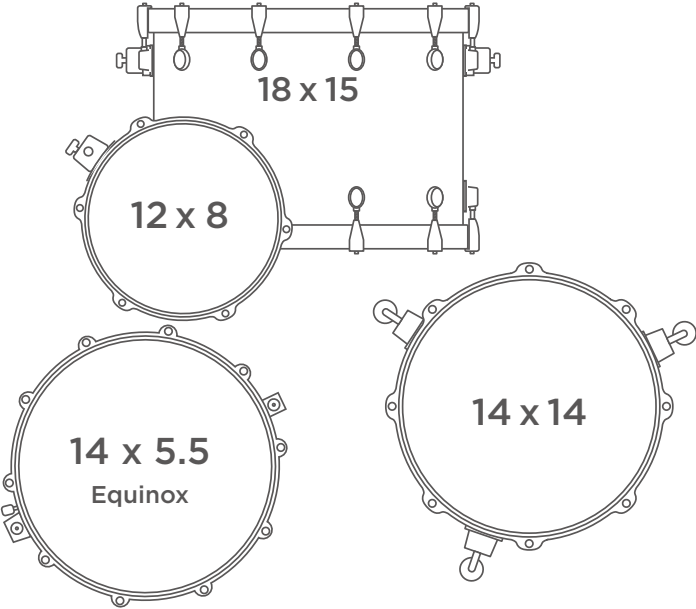

"The drums can be wide open, these drums will allow you to get that sound. I've never heard that much sound from a floor tom."

Greg Hutchinson's concept of sound takes an unconventional, radical approach to the jazz tradition in which he's rooted, reflected in his choice of Versatus drums. Chamber-specific ply thicknesses and the SAS ring system bring focus, edge, and control to totally uninhibited shell resonance.

GREG HUTCHINSON

JOSHUA REDMAN



ARTIST KIT CHOICE

VERSATUS

Finish: Satin Black (SAS 2) / Matching BD Hoops
Hardware: Chrome / Hoops: Triple-flanged

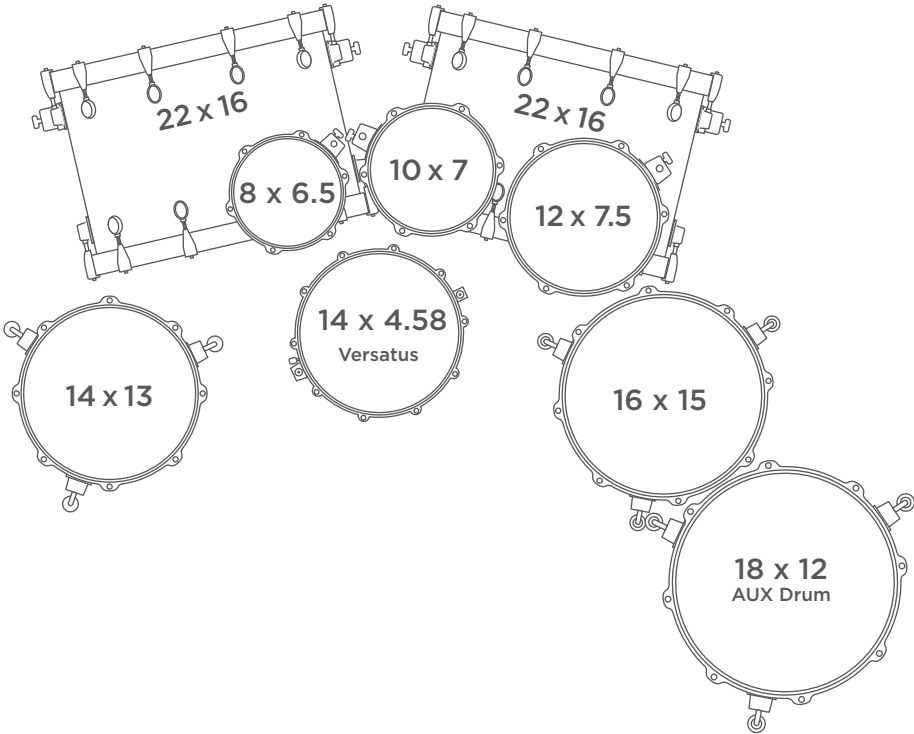

"This finally gives me the possibility to play the bass drum completely open, and still have the focused sound that I need."

The Versatus drum kit proves itself more than a match for metal titan Alex Landenburg's blistering virtuosity. From whispering ghost notes to roaring full-bore, the sonic headroom afforded by the maple/mahogany hybrid shell design preserves integrity and amplitude of tone at every level of the dynamic spectrum.

ALEX LANDENBURG

CYHRA



ARTIST KIT CHOICE

VERSATUS

Finish: Peach Burl Burst (SAS 2) / Matching BD Hoops

Hardware: Black Brushed / Hoops: Triple-flanged

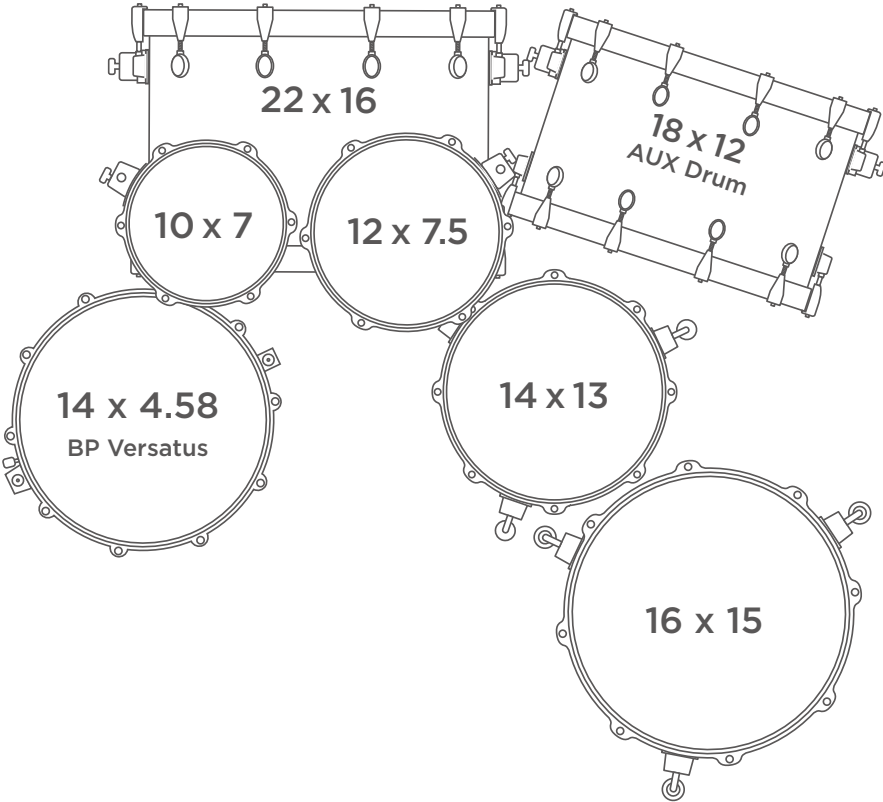

" This thing just sounds perfect: pre-EQ'd, I would call it, or pre-processed even. It's a little deeper than just EQ'ing the high end and low end: it's the processing of the drums that you might do in a mix, but it does it all naturally on the instrument."

Multiple-Platinum award-winning recording artist Russ Miller plays on the Versatus system kit. The "Hi-Fi" sound of the Versatus, supports his 20+ year reign in the top studios in the world. Russ' unique sound is complemented by the innovative acoustic designs that create a pre-processed tone, which would otherwise require exterior means to achieve.

RUSS MILLER

27X'S PLATINUM RECORDING ARTIST,
AMERICAN IDOL, ANDREA BOCELLI



ARTIST KIT CHOICE

VERSATUS BD / CHERRY BOMB TOMS

Finish: Gold Sparkle Burst (SAS 2) / Matching BD Hoops

Hardware: Chrome/ Hoops: Sonic Saver

VERSATUS Gold Sparkle Burst Bass Drum

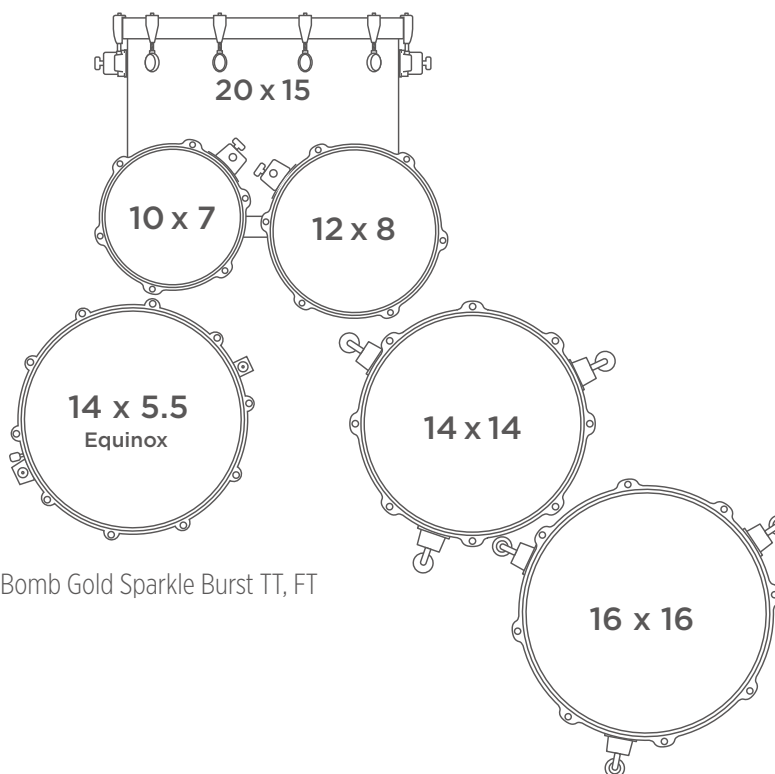

Cherry Bomb Gold Sparkle Burst TT, FT

" It's cool to play one drum set and be able to play five to ten different styles of music on it. The response of the drums are so easy that I can play soft and still get a beautiful sound, but I can also dig into the drum without choking the drum."

From arenas to clubs, Lee Pearson adopts the Cherry Bomb as the voice of his artistry. His melodic approach to the drums takes full advantage of the warmth and quick response of the toms, with an unparalleled range of tuning which allows for precision when finesse is required while retaining breadth of tone when a heavier touch is applied.

LEE PEARSON

CHRIS BOTTI



ARTIST KIT CHOICE

CHERRY BOMB

Finish: Satin Black (SAS 0) / Matching BD Hoops

Hardware: Chrome / Hoops: Sonic Saver

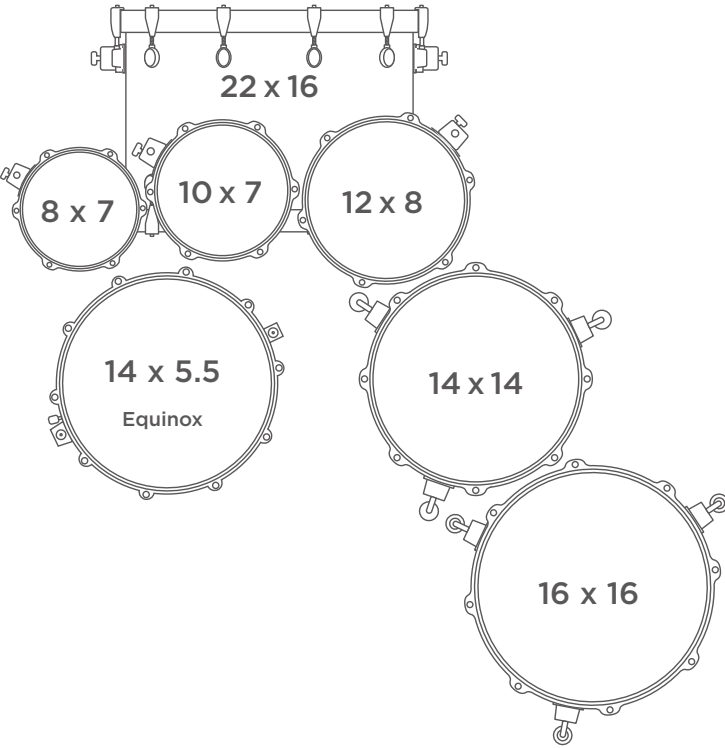

"These new drums have literally made playing more comfortable and a lot more enjoyable. Now you are getting the actual pitch that you need, but you still get the warmth."

The chamber-specific ply design of the Cherry Bomb toms allows Rashid Williams to feel the optimum shell resonance and vibration from behind the drums. The SAS ring system of the Versatus bass drum preserves a full, open dynamic range but attenuates the standing wave, negating the need for muffling.

RASHID WILLIAMS

JOHN LEGEND











BLACK PANTHER
designLAB



MAPEXDESIGNLAB.COM